

Godox 神牛

TTL 锂电机顶闪光灯  
Pioneering TTL Li-ion Camera Flash

V860 II<sup>N</sup>

For Nikon

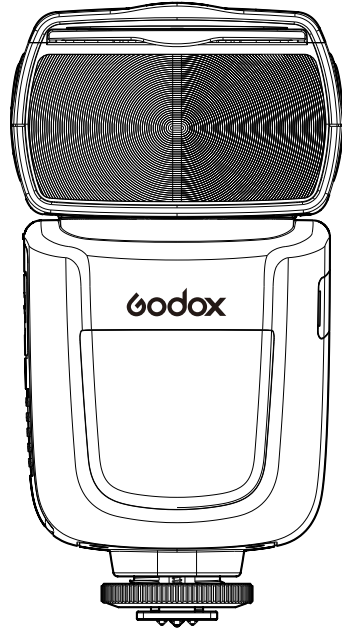

INSTRUCTION MANUAL  
说明书

中英文双语 / Chinese English Bilingual

### 深圳市神牛摄影器材有限公司

GODOX Photo Equipment Co., Ltd.

地址/Add: 深圳市宝安区福永镇福洲大道西新和村华发工业园A4栋  
Building A4, Xinhe Huafa Industrial Zone, Fuzhou RD West, Fuyong  
Town, Baoan District, Shenzhen 518103, China  
电话/Tel: +86-755-29609320(8062) 传真/Fax: +86-755-25723423  
邮箱/E-mail: godox@godox.com  
http://www.godox.com

705-V8602N-00

Made In China



#### 在使用本产品之前：

请先仔细阅读本手册，以确保您能安全使用。请保存好本手册以备将来查询参考。

#### Before using this product:

Please read this user manual carefully in order to ensure your safety and the proper operation of this product. Keep for future reference.









## Foreword

### Thank you for purchasing this product.



This V860iIN camera flash applies to Nikon DSLR series cameras and is compatible with i-TTL autoflash. With this i-TTL compatible flash, your shooting will become simpler. You can easily achieve a correct flash exposure even in complex light-changing environments. This camera flash features:

- GN60 (m ISO 100, @200mm), 22 steps from 1/1 to 1/128.
- Pro 2000mAh Li-ion Battery-max.1.5s recycle-650 full power pops.
- Fully support Nikon i-TTL camera flash. Workable as Master or Slave unit in a wireless flash group.
- Use dot-matrix LCD panel to make clear and convenient operations.
- With built-in 2.4GHz wireless remote system to support transmitting and receiving.
- Provided multiple functions, include HSS (up to 1/8000s), FEC, etc.
- Use optional FT-16S to adjust flash parameters & trigger the flash.
- Stable consistency and color temperature with good even lighting.
- Support with firmware upgrade.

## Warning



-  Always keep this product dry. Do not use in rain or in damp conditions.
-  Do not disassemble. Should repairs become necessary, this product must be sent to an authorized maintenance center.
-  Keep out of reach of children.
-  Stop using this product if it breaks open due to extrusion, falling or strong hit. Otherwise, electric shock may occur if you touch the electronic parts inside it.
-  Do not fire the flash directly into the eyes (especially those of babies) within short distances. Otherwise visual impairment may occur.
-  Do not use the flash unit in the presence of flammable gases, chemicals and other similar materials. In certain circumstance, these materials may be sensitive to the strong light emitting from this flash unit and fire or electromagnetic interference may result.
-  Do not leave or store the flash unit if the ambient temperature reads over 50°C. Otherwise the electronic parts may be damaged.
-  Turn off the flash unit immediately in the event of malfunction.

# Contents

31	<b>Foreword</b>
32	<b>Warning</b>
35	<b>Name of Parts</b>
	Body
	Control Panel
	Dot-matrix LCD Panel
	What's in the Box of V860IIN Kit?
	What's in the Box of V860IIN (only flash unit)?
	Separately Sold Accessories
38	<b>Battery</b>
39	<b>Attaching to a Camera</b>
39	<b>Power Management</b>
40	<b>Flash Mode — i-TTL Autoflash</b>
	 FEC (Flash Exposure Compensation)
	 High-Speed Sync
	 Second-Curtain Sync
42	<b>Flash Mode — M: Manual Flash</b>
43	<b>Flash Mode — RPT: Stroboscopic Flash</b>
44	<b>Wireless Flash Shooting: Optic Transmission</b>
	Wireless Settings
	Setting Master Unit's Flash Mode
	Setting the Communication Channel
	i-TTL: Fully Automatic Wireless Flash Shooting
	M: Wireless Flash Shooting with Manual Flash
	RPT: Wireless Flash Shooting with Manual Flash
48	<b>Wireless Flash Shooting: Radio (2.4G) Transmission</b>
	Wireless Settings
	Setting Master Unit's Flash Mode
	Setting the Communication Channel
	i-TTL: Fully Automatic Wireless Flash Shooting
	M: Wireless Flash Shooting with Manual Flash
	RPT: Wireless Flash Shooting with Manual Flash
52	<b>Other Applications</b>
	Wireless Control Function
	Sync Triggering
	Modeling Flash
	Auto Focus Assist Beam
	Bounce Flash
	Creating a Catchlight
	ZOOM: Setting the Flash Coverage and Using the Wide Panel
	Low Battery Indicator
55	<b>C.Fn: Setting Custom Functions</b>
56	<b>Protection Function</b>
57	<b>Technical Data</b>
58	<b>Troubleshooting</b>
59	<b>Firmware Upgrade</b>
59	<b>Compatible Camera Models</b>
59	<b>Maintenance</b>



## Conventions used in this Manual

- This manual is based on the assumption that both the camera and camera flash's power switches are powered on.
- Reference page numbers are indicated by "p.\*\*".
- The following alert symbols are used in this manual:
  -  The Caution symbol gives supplemental information.
  -  The Note symbol indicates a warning to prevent shooting problem.

## Name of Parts

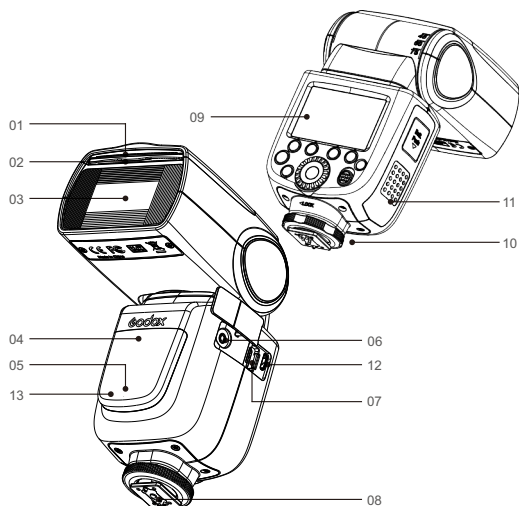

### ● Body

- |                           |                                 |
|---------------------------|---------------------------------|
| 01. Catchlight Panel      | 08. Hotshoe                     |
| 02. Built-in Wide Panel   | 09. Dot-matrix LCD Panel        |
| 03. Flash Head            | 10. Lock Ring                   |
| 04. Optic Control Sensor  | 11. Battery Compartment         |
| 05. Focus Assist Beam     | 12. USB Port                    |
| 06. Sync Cord Jack        | 13. Slave Flash Ready Indicator |
| 07. Wireless Control Port |                                 |

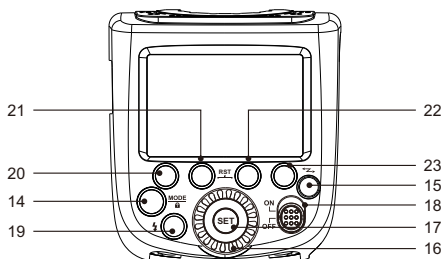

### ● Control Panel

- |  |   |
|--|---|
| 14. <MODE> Mode Selection Button / Lock button | 19. <⚡> Test Button / Flash Ready Indicator |
| 15. <Z> Wireless Selection Button              | 20. Function Button 1                       |
| 16. Select Dial                                | 21. Function Button 2                       |
| 17. <SET> Set Button                           | 22. Function Button 3                       |
| 18. ON/OFF Power Switch                        | 23. Function Button 4                       |

## ● LCD Panel

### (1)i-TTL Autoflash

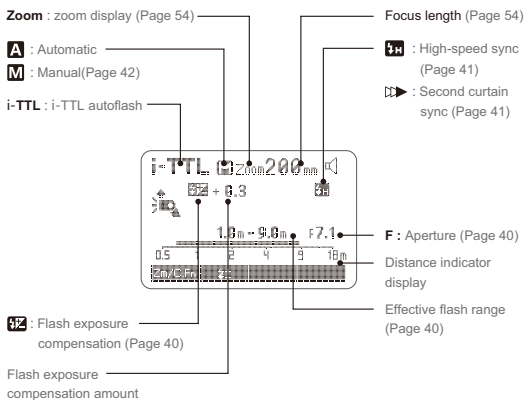

- The display will only show the settings currently applied.
- The functions displayed above function buttons 1 to 4, such as **SYNC** and **±**, change according to settings' status.
- When a button or dial is operated, the LCD panel illuminated.

### (2)M Manual Flash

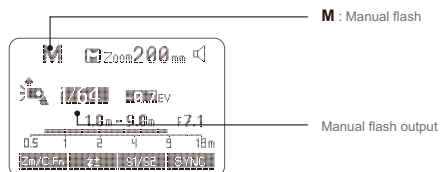

### (3)Multi Flash

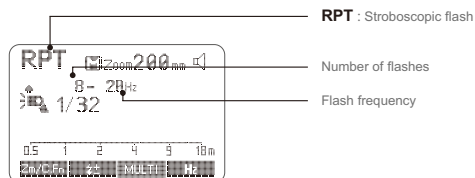

#### (4) Radio Transmission Shooting/Optic Transmission Shooting

##### ● Master Unit

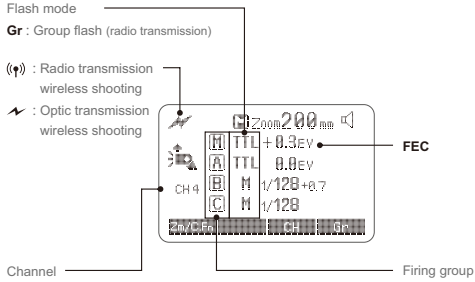

##### ● Slave Unit

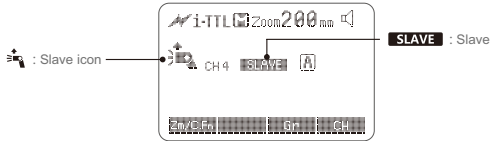

##### ● What's in the Box of V860IIN Kit?

1. Flash Unit
2. Li-ion Battery Pack
3. Battery Charger
4. Battery Charger Cable
5. Mini Stand
6. Protection Case
7. Instruction Manual

##### ● What's in the Box of V860IIN (only flash unit)?

1. Flash Unit
5. Mini Stand
6. Protection Case
7. Instruction Manual



##### ● Separately Sold Accessories

The product can be used in combination with the following accessories sold separately, so as to achieve best photography effects:

X1N TTL wireless flash trigger, FT-16S power & trigger control, Mini softbox, White & Silver reflector, Honeycomb, Color gels, Snoot, etc.



#### Battery

##### ● Features

1. This flash unit uses Li-ion polymer battery which has long runtime. The available charge-and-discharge times are 500.
2. It is reliably safe. The inner circuit is against overcharge, overdischarge, overcurrent, and short circuit.
3. Take only 2.5 hours to fully charge the battery by using the standard battery charger.

##### ● Cautions

1. Do not short circuit.
2. Do not expose to rain or immerse into water. This battery is not water proof.
3. Keep out of reach of children.
4. No over 24 hours' continuous charging.
5. Store in dry, cool, ventilated places.
6. Do not put aside or into fire.
7. Dead batteries should be disposed according to local regulations.
8. If the battery had ceased using for over 3 months, please make a full recharge.

##### ● Loading and Unloading the Battery

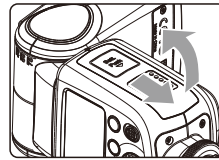

- 1 To load the battery, push the battery compartment cover downward and open it.

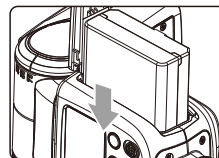

- 2 According to the triangle sign on the battery pack, insert it into the compartment until a white knob locks the battery with a click sound.

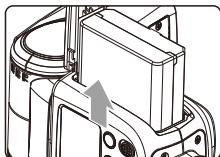

- To unload the battery, tap the white knob and the battery pack will pop out. Then close the compartment.

### ● Battery Level Indication

Make sure the battery pack is securely loaded in the flash. Check the battery level indication on the LCD panel to see the remaining battery level.

Battery Level Indication	Meaning
3 grids	Full
2 grids	Middle
1 grid	Low
Blank grid	Lower battery, please recharge it.
Blinking	The battery level is going to be used out immediately. And the flash will auto power off in 1 minute. Note: Please recharge the battery as soon as possible (within 10 days). Then, the battery can be used or be placed for long period.

### Attaching to a Camera

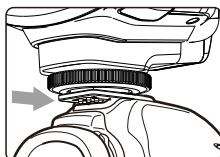

- Attach the Camera Flash.
  - Slip the camera flash's mounting foot into the camera's hotshoe all the way.

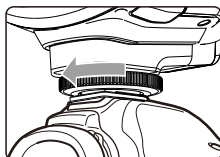

- Secure the Camera Flash.
  - Rotate the lock ring on the mounting foot until it locks up.

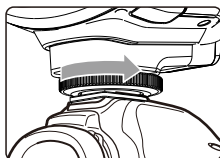

- Detach the Camera Flash.
  - Rotate the lock ring on the mounting foot until it is loosened.

### Power Management

Use ON/OFF Power Switch to power the flash unit on or off. Turn off if it will not be used for an extended period of time. Setting as a master flash, it will turn the power off automatically after a certain period (approx. 90 seconds) of idle use. Pressing the camera shutter halfway or pressing any flash button will wake up the flash unit. Setting as a slave flash, it will enter sleep mode after a certain period (adjustable, 60 minutes by default) of idle use. Pressing any flash button will wake it up.

- C.Fn** Disabling Auto Power Off function is recommended when the flash is used off camera. (C.Fn-AP0, Page 55)
- C.Fn** Slave Auto Power Off Timer is set to 60 minutes by default. Another option "30 minutes" is available. (C.Fn-Sv AP0T, Page 55)

### Flash Mode — i-TTL Autoflash

This flash has three flash modes: i-TTL, Manual (M), and RPT (Stroboscopic). In i-TTL mode, the camera and the flash will work together to calculate the correct exposure for the subject and the background. In this mode, multiple TTL functions are available: FEC, HSS, second curtain sync, modeling flash, etc.

\* Press **< MODE >** Mode Selection Button and three flash modes will display on the LCD panel one by one with each pressing.

#### i-TTL Mode

Press **< MODE >** Mode Selection Button to enter i-TTL mode. The LCD panel will display.

- Press the camera release button halfway to focus. The aperture and effective flash range will be displayed in the viewfinder.
- When the shutter button is fully pressed, the flash will fire a pre-flash that the camera will use to calculate exposure and flash output the instant before the photo is taken.

#### FEC: Flash Exposure Compensation

With FEC function, this flash can adjust from -3 to +3 in 1/3rd stops. It is useful in situations where minor adjusting of the TTL system is needed based on the environment.

#### Setting FEC:

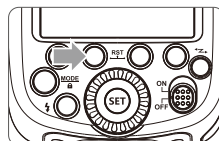

- Press Function **Button 2** **< +/- >**. The icon **< +/- >** and flash exposure compensation amount will be highlighted on the LCD panel.

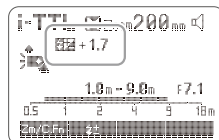

- Set the flash exposure compensation amount.
  - Turn the Select Dial to set the amount.
  - "0.3" means 1/3 step, "0.7" means 2/3 step.
  - To cancel the flash exposure compensation, set the amount to "+0".

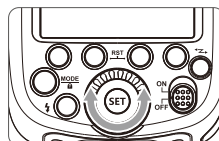



- Press **< SET >** button again to confirm the setting.

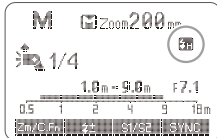

## High-Speed Sync

High Speed Sync (FP flash) enables the flash to synchronize with all camera shutter speeds. This is convenient when you want to use aperture priority for fill-flash portraits.

Select the high-speed sync icon <  >.



- Set the flash sync speed to 1/320s (Auto FP) or 1/250s (Auto FP) in the Nikon camera menu. Press the shutter button halfway. The icon <  > displayed on the flash screen means the high speed sync function is enabled on the flash.
- Turning the camera command dial can set the shutter speed to 1/250s or faster.
- To check if the FP flash function works properly, look through the shutter speed in the viewfinder. If it shows a speed of 1/250s or faster, the FP flash function is on work.

- If you set a shutter speed as 1/320s (Auto FP) or 1/250s (Auto FP) in the Nikon camera setting, <  > will be displayed in the flash screen regardless of practical shutter speed.
- With high-speed sync, the faster the shutter speed, the shorter the effective flash range.
- To return to normal flash, set the flash sync speed to other options other than Auto FP. Then the icon <  > will disappear when pressing the shutter halfway.
- Multi flash mode cannot be set in high-speed sync mode.
- Over-temperature protection may be activated after 15 consecutive high-speed sync flashes.

## Second-Curtain Sync

With a slow shutter speed, you can create a light train following the subject. The flash fires right before the shutter closes.

- Set the camera to Rear mode to achieve second curtain sync.
- Set the camera to Non Rear mode to cancel second curtain sync.

## Flash Mode — M: Manual Flash

The flash output is adjustable from 1/1 full power to 1/128th power in 1/3rd stop increments. To obtain a correct flash exposure, use a hand-held flash meter to determine the required flash output.

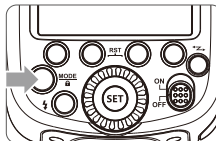

- 1 Press < **MODE** > button so that < **M** > is displayed.

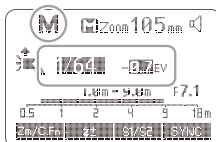

- 2 Turn the Select Dial to choose a desired flash output amount.

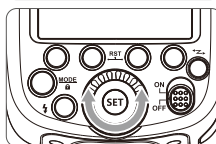

- 3 Press < **SET** > button again to confirm the setting.

### Flash Output Range

The following table makes it easier to see how the stop changes in terms of *f*/stop when you increase or decrease the flash output. For example, when you decrease the flash output to 1/2, 1/2-0.3, or 1/2-0.7, and then increase the flash output to more than 1/2, 1/2+0.3, 1/2+0.7, and 1/1 will be displayed.

Figures displayed when reducing flash output level →

1/1	1/1-0.3	1/1-0.7	1/2	1/2-0.3	1/2-0.7	1/4	.....
	1/2+0.7	1/2+0.3		1/4+0.7	1/4+0.3		.....

← Figures displayed when increasing flash output level

### Optic S1 Secondary Unit Setting

In M manual flash mode, press < **S1/S2** > button so that this flash can function as an optic S1 secondary flash with optic sensor. With this function, the flash will fire synchronously when the main flash fires, the same effect as that by the use of radio triggers. This helps create multiple lighting effects.

### Optic S2 Secondary Unit Setting

Press < **S1/S2** > button so that this flash can also function as an optic S2 secondary flash with optic sensor in M manual flash mode. This is useful when cameras have pre-flash function. With this function, the flash will ignore a single "pre-flash" from the main flash and will only fire in response to the second, actual flash from the main unit.

### Manual Off Camera High-speed Setting

In M manual flash mode, press < **SYNC** > button to select high-speed mode and <  > is displayed.

- S1 and S2 optic triggering and off camera high-speed mode are only available in M manual flash mode.

## Flash Mode — RPT: Stroboscopic Flash

With stroboscopic flash, a rapid series of flashes is fired. It can be used to capture a multiple images of a moving subject in a single photograph.

You can set the firing frequency (number of flashes per sec. expressed as Hz), the number of flashes, and the flash output.

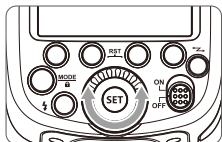
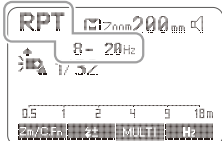
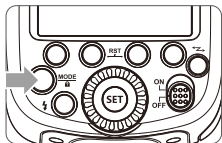

- 1 Press <MODE> button so that <RPT> is displayed.
- 2 Turn the Select Dial to choose a desired flash output.

- 3 Set the flash frequency and flash times.
  - Press Function Button 3 <MULTI> button to select the item (blinks).
  - Turn the Select Dial to set the number and press Function Button 4 <Hz> button again to confirm. The next item to be set will blink.
  - After you finish the setting, press <SET> button and all the settings will be displayed.

### Calculating the Shutter Speed

During stroboscopic flash, the shutter remains open until the firing stops. Use the formula below to calculate the shutter speed and set it with the camera.

$$\text{Number of Flashes} / \text{Flash Frequency} = \text{Shutter Speed}$$

For example, if the number of flashes is 10 and the firing frequency is 5 Hz, the shutter speed should be at least 2 seconds.

- ⚠ To avoid overheating and deteriorating the flash head, do not use stroboscopic flash more than 10 times in succession. After 10 times, allow the camera flash to rest for at least 15 minutes. If you try to use the stroboscopic flash more than 10 times in succession, the firing might stop automatically to protect the flash head. If this happens, allow at least 15 minutes' rest for the camera flash.

- 📌
- Stroboscopic flash is most effective with a highly reflective subject against a dark background.
  - Using a tripod and a remote control is recommended.
  - A flash output of 1/1 and 1/2 cannot be set for stroboscopic flash.
  - Stroboscopic flash can be used with "buLb".
  - If the number of flashes is displayed as "--", the firing will continue until the shutter closes or the battery is exhausted. The number of flashes will be limited as shown by the following table.

### Maximum Stroboscopic Flashes:

Flash output \ Hz	1	2	3	4	5	6-7	8-9
1/4	7	6	5	4	4	3	3
1/8	14	14	12	10	8	6	5
1/16	30	30	30	20	20	20	10
1/32	60	60	60	50	50	40	30
1/64	90	90	90	80	80	70	60
1/128	90	90	90	90	90	90	80

Flash output \ Hz	10	20-50	60-100			
1/4	2	2	2			
1/8	4	4	4			
1/16	8	8	8			
1/32	20	16	12			
1/64	50	30	20			
1/128	70	40	40			

## Wireless Flash Shooting: Optic Transmission

This product is compatible with Nikon Creative Lighting System (CLS). It can function as either an optic wireless master or slave flash. As a master unit, it can control Nikon speedlights e.g. SB-900 and SB-910 via wireless. As a slave unit, it can be controlled by wireless signals of Nikon speedlights e.g. SB-900 and pop-up flash commanders of Nikon cameras e.g. D7100/D7000/D800.

- You can set up three slave groups for i-TTL autoflash shooting. With i-TTL autoflash, you can easily create various lighting effects.
- Any flash settings for the slave units on the master flash in i-TTL / Manual / RPT mode will be automatically sent to the slave units. So the only thing you need to do is to set the master unit for each slave group without any operation for the slave units at all during the shooting.
- This flash can work in i-TTL / M / RPT / OFF flash modes when set as a master unit.

### Slave/Master Unit's Positioning and Operation Range

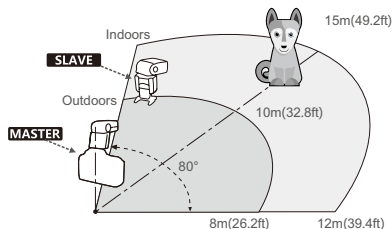



- Even with multiple slave units, the master unit can control all of them via wireless.
- In this user manual, "master unit" refers to the camera flash on a camera and "slave unit" will be controlled by the master unit.

## 1. Wireless Settings

You can switch between normal flash and wireless flash. For normal flash shooting, be sure to set the wireless setting to OFF.

### Master Unit Setting

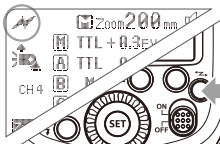

Press < < > > button so that < < > > is displayed on the LCD panel. If < < RPT > > is displayed, it means RPT mode is ON. The backlight turns green now.

### Slave Unit Setting



Press < < > > button again so that < < > > and < SLAVE > are displayed on the LCD panel. The backlight turns orange now.

## 2. Setting Master Unit's Flash Mode

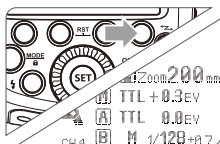

1 Press Function **Button 4** < **Gr** > to choose the group from M/A/B/C. Then, press Function **Button 3** < **MODE** > so that the master unit can work in OFF / i-TTL / M flash mode. Choose one of them as the flash mode of master unit.

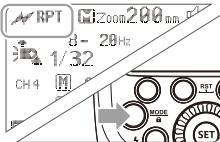

2 Press the "MODE/Lock" button can change to RPT mode.

## 3. Setting the Communication Channel

If there are other wireless flash systems nearby, you can change the channel IDs to prevent signal interference. The channel IDs of the master unit and the slave unit(s) must be set to the same.

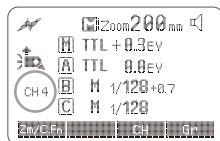

1 Press Function **Button 3** < **CH** > and turn the Select Dial to choose a channel ID from 1 to 4.  
2 Press the <SET> button to confirm.

## 4. i-TTL: Fully Automatic Wireless Flash Shooting

### Using Automatic Wireless Flash with a Single Slave Unit

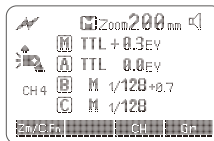

### 1 Master Unit Setting

- Attach a V860IIN camera flash on the camera and set it as the master Unit. (Page 45)
- M/A/B/C can be set as TTL mode independently.

### 2 Slave Unit Setting

- Set the other camera flash as the wireless slave Unit. (Page 45)
- The slave unit can be set as A/B/C.

### 3 Check the communication channel.

- If the master unit and slave unit(s) are set to a different channel, set them to the same channel. (Page 45)

### 4 Position the camera and flashes.

- Position the camera and flashes as the picture shows. (Page 44)

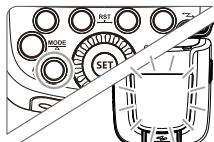

### 5 Check that the flash is ready.

- Check that the master flash ready indicator is lightened.
- When the slave flash ready indicator is ready, the AF-assist beam lighting area will blink at 1 second intervals.

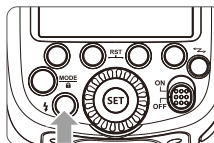

### 6 Check the flash operation.

- Press the master unit's Test Button < < > >.
- Then, the slave unit will fire. If not, adjust the slave unit's angle toward the master unit and distance from the master unit.

▲ The slave unit might be out of order or fire an unwanted flash due to the nearby fluorescent lamp or computer screen.

- If the slave unit's auto power off function is workable, press the master unit's test button to power it on. Please note that test firing is unavailable during the camera's regular metering time.
- The effective time of slave auto power off is changeable. (C.Fn-Sv APOT Page 55)
- By making some settings, the auto AF-assist transmitter will not blink after the slave unit's flash ready indicator is lightened. (C.Fn-AF Page 55)

## Using Fully Automatic Wireless Flash

The FEC and other settings that set on the master unit will also be appeared on the slave unit automatically. The slave unit does not need any operation. Use the following settings to make wireless flashes according to the same methods with normal flash shooting.

- Flash Exposure Compensation ( Page 40)
- High-Speed Sync ( **SYNC** Page 41)

## About Master Unit

Use two or more master units. By preparing several cameras that with master units flash attached, cameras can be changed in shooting while keeping the same lighting source (slave unit).

## 5. M: Wireless Flash Shooting with Manual Flash

This describes wireless (multiple shooting) using manual flash. You can shoot with a different flash output setting for each slave unit (firing group). Set all parameters on the master unit.

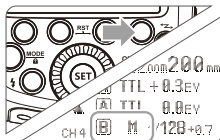

### 1 Setting the flash mode to <M>.

- Press Function **Button 4** to choose groups. Then, press Function **Button 3** to set the flash to **M** mode.

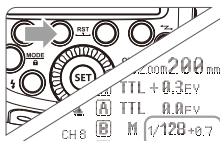

### 2 Setting flash output.

- Press Function **Button 2** . Turn the Select Dial to set the flash output of the groups. Press the **<SET>** button to confirm.

### 3 Taking the picture.

- Each group fires at the set flash ratio.

## 6. RPT: Wireless Flash Shooting with Manual Flash

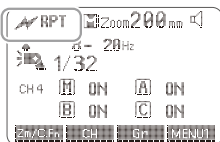

### Setting <RPT> stroboscopic flash.

- Press **<MODE>** button so that **<RPT>** is displayed.
- Setting the stroboscopic flash. (Page 43)

The firing frequency of stroboscopic flash during the optic transmission wireless shooting can be set from 1Hz to 100Hz (settings from 250 Hz to 500 Hz are not available).

## Wireless Flash Shooting: Radio (2.4G) Transmission

- You can set up three slave groups for TTL autoflash shooting. With TTL autoflash, you can easily create various lighting effects.
- Any flash settings for the slave units on the master flash in TTL mode will be automatically sent to the slave units. So the only thing you need to do is to set the master unit for each slave group without any operation for the slave units at all during the shooting.
- This flash can work in i-TTL / M / Multi / OFF flash modes when set as a master unit.

- Even with multiple slave units, the master unit can control all of them via wireless.
- In this user manual, "master unit" refers to the camera flash on a camera and "slave unit" will be controlled by the master unit.

## 1. Wireless Settings

You can switch between normal flash and wireless flash. For normal flash shooting, be sure to set the wireless setting to OFF.

### Master Unit Setting

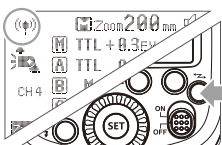

- Press **<RPT>** button so that **<RPT>** is displayed on the LCD panel. If **<RPT>** is displayed, it means RPT mode is ON.

- The backlight turns green now.

### Slave Unit Setting

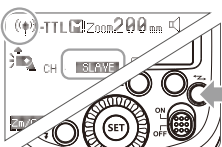

- Press **<RPT>** button again so that **<RPT>** and **<SLAVE>** are displayed on the LCD panel.

- The backlight turns orange now.

## 2. Setting Master Unit's Flash Mode

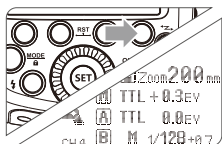

- Press Function **Button 4** to choose the group from M/A/B/C. Then, press Function **Button 3** so that the master unit can work in OFF / i-TTL / M flash mode. Choose one of them as the flash mode of master unit.

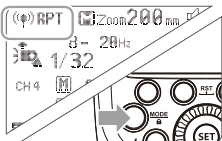

- Press the "MODE/Lock" button can change to RPT mode.

### 3. Setting the Communication Channel

If there are other wireless flash systems nearby, you can change the channel IDs to prevent signal interference. The channel IDs of the master unit and the slave unit(s) must be set to the same.

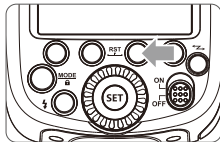

- 1 Press Function **Button 3** < **CH** > and turn the Select Dial to choose a channel ID from 1 to 32.
- 2 Press the <SET> button to confirm.

### 4. i-TTL: Fully Automatic Wireless Flash Shooting

#### Using Automatic Wireless Flash with a Single Slave Unit

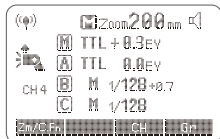

- 1 **Master Unit Setting**
  - Attach a V860IIN camera flash on the camera and set it as the master Unit. (Page 48)
  - M/A/B/C can be set as TTL mode independently.



- 2 **Slave Unit Setting**
  - Set the V860IIN to be controlled as the wireless slave unit. (Page 48)
  - The slave unit can be set as A/B/C.

- 3 **Check the communication channel.**
  - If the master unit and slave unit(s) are set to a different channel, set them to the same channel. (Page 49)

- 4 **Position the camera and flashes.**
  - Position the camera and flashes as the picture shows. (Page 44)

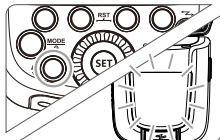

- 5 **Check that the flash is ready.**
  - Check that the master flash ready indicator is lightened.
  - When the slave flash ready indicator is ready, the AF-assist beam lighting area will blink at 1 second intervals.

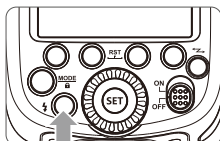

- 6 **Check the flash operation.**
  - Press the master unit's Test Button < **⚡** >.
  - Then, the slave unit will fire. If not, adjust the slave unit's angle toward the master unit and distance from the master unit.

⚠ The slave unit might be out of order or fire an unwanted flash due to the nearby fluorescent lamp or computer screen.

- 6
  - If the slave unit's auto power off function is workable, press the master unit's test button to power it on. Please note that test firing is unavailable during the camera's regular metering time.
  - The effective time of slave auto power off is changeable. (C.Fn-Sv APOT Page 55)
  - By making some settings, the auto AF-assist transmitter will not blink after the slave unit's flash ready indicator is lightened. (C.Fn-AF Page 55)

#### Using Fully Automatic Wireless Flash

The FEC and other settings that set on the master unit will also be appeared on the slave unit automatically. The slave unit does not need any operation. Use the following settings to make wireless flashes according to the same methods with normal flash shooting.

- Flash Exposure Compensation ( **⚡** Page 40)

#### About Master Unit

Use two or more master units. By preparing several cameras that with master units flash attached, cameras can be changed in shooting while keeping the same lighting source (slave unit).

### 5. M: Wireless Flash Shooting with Manual Flash

This describes wireless (multiple shooting) using manual flash. You can shoot with a different flash output setting for each slave unit (firing group). Set all parameters on the master unit.

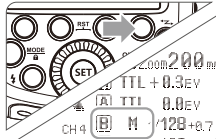

- 1 **Setting the flash mode to <M>.**
  - Press Function **Button 4** < **Gr** > to choose groups. Then, press Function **Button 3** < **MODE** > to set the flash to **M** mode.

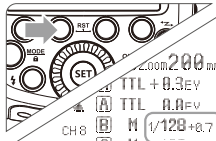

- 2 **Setting flash output.**
  - Press Function **Button 2** < **⚡** >. Turn the Select Dial to set the flash output of the groups. Press the <SET> button to confirm.
- 3 **Taking the picture.**
  - Each group fires at the set flash ratio.

### 6. RPT: Wireless Flash Shooting with Manual Flash

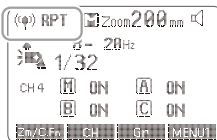

**Setting < RPT > stroboscopic flash.**

- Press <MODE> button so that < **RPT** > is displayed.
- Setting the stroboscopic flash. (Page 43)

Using a flash (master/slave) with a radio transmission wireless shooting function make it easy to shoot with advanced wireless multiple flash lighting, in the same way as TTL autoflash shooting. The basic relative position and operation range are as shown in the picture. You can then perform wireless TTL autoflash shooting just by setting the master unit to <TTL>.

### Slave/Master Unit's Positioning and Operation Range

- Autoflash Shooting with One Slave Unit

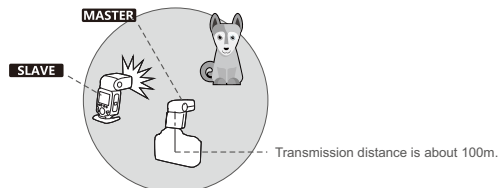

- Use the supplied mini stand to position the slave unit.
- Before shooting, perform a test flash and test shooting.
- The transmission distance might be shorter depending on the conditions such as positioning of slave units, the surrounding environment and whether conditions.

### Wireless Multiple Flash Shooting

You can divide the slave units into two or three groups and perform i-TTL autoflash while changing the flash ratio (factor). In addition, you can set and shoot with a different flash mode for each firing group, for up to 5 groups.

- Auto Shooting with Two Slave Groups

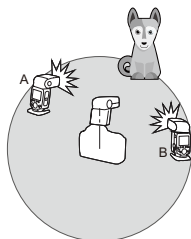

- Auto Shooting with Three Slave Groups

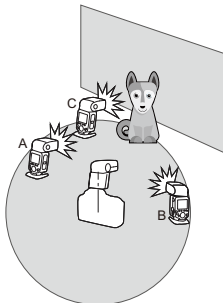

Wireless shooting using radio transmission has advantages over wireless shooting using optic transmission, such as being less affected by obstacles, and not having to point the slave unit's wireless sensor toward the master unit. The main functional differences are as follows:

Function	Radio Transmission	Optic Transmission
Distance	100m	15m
Channel	1~32	1~4
To be disturbed	Hard	Easy

## Other Applications

### Wireless Control Function

The flash unit is built in with a Wireless Control Port so that you can wirelessly adjust the power level of the flash and the flash triggering. To control the flash wirelessly, you need a FT-16S remote control set (on-camera and on-flash). Insert its receive end into the Wireless Control Port on the flash and insert the transmit end into the camera hot shoe. Settings made on the hotshoe-mounted transmit and receive ends will be wirelessly communicated to the flash. Then you can press the camera shutter release button to trigger the flash. You can also hold the transmit end at hand to control your off-camera flash.



- For full instructions on the use of FT series remote control, see its user manual.

### Sync Triggering

The Sync Cord Jack is a  $\Phi 2.5\text{mm}$  plug. Insert a trigger plug here and the flash will be fired synchronously with the camera shutter.

## Modeling Flash

If the camera has a depth-of-field preview button, pressing it will fire the flash continuously for 1 second. This is called modeling flash. It enables you to see the shadow effects on the subject and the lighting balance. You can fire the modeling flash during wireless or normal flash shooting.

- ▲ • To avoid overheating and deteriorating the flash head, do not fire the modeling flash for more than 10 consecutive times. If you fire the modeling flash 10 consecutive times, allow at least 10 minutes' break for the camera flash.

## Auto Focus Assist Beam

In poorly-lit or low-contrast shooting environments, the built-in auto focus assist beam will automatically light on to make it easier for autofocus. The beam will light up only when autofocus is difficult and get out as soon as the autofocus becomes correct.

If you want to turn off the auto focus assist beam, set the "AF" to "OFF" on the C.Fn settings.

- 📌 • If you find the auto focus assist beam does not light up, this is because the camera has got a correct autofocus.

Position	Effective Range
Center	0.6~10m / 2.0~32.8 feet
Periphery	0.6~5m / 2.0~16.4 feet

## Bounce Flash

By pointing the flash head toward a wall or ceiling, the flash will bounce off the surface before illuminating the subject. This can soften shadows behind the subject for a more natural-looking shot. This is called bounce flash.

**To set the bounce direction, hold the flash head and turn it to a satisfying angle.**

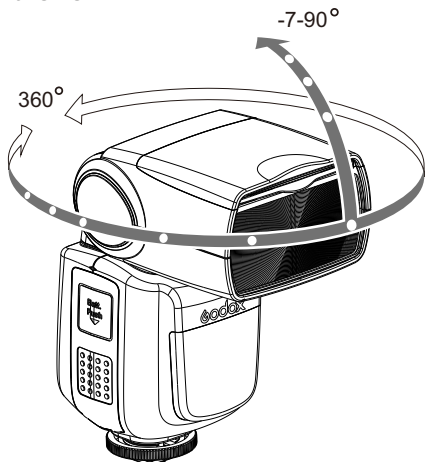

- 📌 • If the wall or ceiling is too far away, the bounced flash might be too weak and result in underexposure.
- The wall or ceiling should be a plain, white color for high reflectance. If the bounce surface is not white, a color cast may appear in the picture.

## Creating a Catchlight

With the catchlight panel, you can create a catchlight in the subject's eyes to add life to the facial expression.

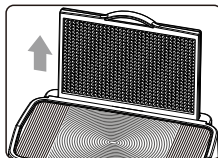

- 1 Point the flash head upward by 90°.
- 2 Pull out the wide panel. The catchlight panel will come out at the same time.

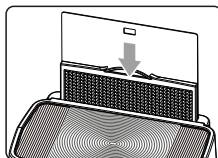

- 3 Push the wide panel back in.
  - Push in only the wide panel.
  - Follow the same procedures as for bounce flash.

- ▲ • Point the flash head straight ahead and then upward by 90°. The catchlight will not appear if you swing the flash head left or right.
- For best catchlight effect, stay 1.5m/4.9ft away from the subject.

## ZOOM: Setting the Flash Coverage and Using the Wide Panel

The flash coverage can be set automatically or manually. It can be set to match the lens focal length from 20 mm to 200mm. Also, with the built-in wide panel, the flash coverage can be expanded for 14mm wide-angle lenses.

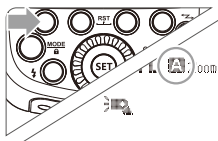

**In Manual Zoom mode, press the <ZOOM/C.FN> button.**

- Turn the Select Dial to change the flash coverage.
- If <A> is displayed, the flash coverage will be set automatically.

- 📌 If you set the flash coverage manually, make sure it covers the lens focal length so that the picture will not have a dark periphery.

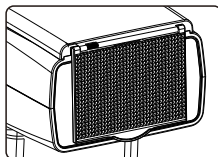

### Using the Wide Panel

Pull out the wide panel and place it over the flash head as shown. The flash coverage will then be extended to 14 mm.

- The catchlight panel will come out at the same time. Push the catchlight panel back in.
- The <ZOOM/C.FN> button will not work.

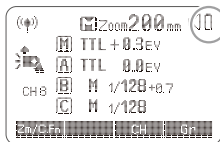

### Low Battery Warning

If the battery power is low,  will appear and blink on the LCD panel. Please replace the battery immediately.

## C.Fn: Setting Custom Functions

The following table lists the available and unavailable custom functions of this flash.

C.Fn Custom Functions			
Custom Function Signs	Function	Setting No.	Settings & Description
m/ft	Distance indicator	m	m
		ft	feet
APO	Auto power off	ON	ON
		OFF	OFF
AF	AF-assist beam	ON	ON
		OFF	OFF
Sv APOT	Slave auto power off timer	60min	60min
		30min	30min
BEEP	Beeper	ON	ON
		OFF	OFF
LIGHT	Backlighting time	12sec	Off in 12 sec.
		OFF	Always off
		ON	Always lighting
LCD	LCD contrast ratio	0-9	10 levels

- Press **<Zm/C.Fn>** Backlight/Custom Setting Button for 2 seconds or longer until C.Fn menu is displayed. The "Ver x.x" in the top-right corner refers to the software version.
- Select the Custom Function No.
  - Turn the Select Dial to choose the Custom Functions.
- Change the Setting.
  - Press **<SET>** button and the Setting No. blinks.
  - Turn the Select Dial to set the desired number. Pressing **<SET>**
- In the C.Fn states, long press the "Clear" button for 2 seconds until "OK" is displayed on the panel, which means the values in C.Fn can be reset.

## Protection Function

### 1. Over-Temperature Protection

- To avoid overheating and deteriorating the flash head, do not fire more than 30 continuous flashes in fast succession at 1/1 full power. After 30 continuous flashes, allow a rest time of at least 10 minutes.
- If you fire more than 30 continuous flashes and then fire more flashes in short intervals, the inner over-temperature protection function may be activated and make the recycling time over 10 seconds. If this occurs, allow a rest time of about 10 minutes, and the flash unit will then return to normal.
- When the over-temperature protection is started,  is shown on the LCD display.

#### Number of flashes that will activate over-temperature protection:

Power Output Level	Number of Flashes
1/1	30
1/2 +0.7	40
1/2 +0.3	50
1/2	60
1/4(+0.3,+0.7)	100
1/8(+0.3,+0.7)	200
1/16(+0.3,+0.7)	300
1/32(+0.3,+0.7)	500
1/64(+0.3,+0.7)	1000
1/128(+0.3,+0.7)	

#### Number of flashes that will activate over-temperature protection in high-speed sync triggering mode:

Power Output	Times
1/1	15
1/2(+0.3,+0.7);	20
1/4(+0.3,+0.7)	30
1/8(+0.3,+0.7);	
1/16(+0.3,+0.7)	40
1/32(+0.3,+0.7);	
1/64(+0.3,+0.7);	50
1/128(+0.3,+0.7);	

### 2. Other Protections

The system provides real-time protection to secure the device and your safety. The following lists prompts for your reference:

Prompts on LCD Panel	Meaning
E1	A failure occurs on the recycling system so that the flash cannot fire. Please restart the flash unit. If the problem still exists, please send this product to a maintenance center.
E2	The system gets excessive heat. Please allow a rest time of 10 minutes.
E3	The voltage on two outlets of the flash tube is too high. Please send this product to a maintenance center.
E9	There are some errors occurred during the upgrading process. Please using the correct firmware upgrade method.

## Technical Data

Model	V860iIN	
<b>• Type</b>		
Compatible Cameras	Nikon DSLR cameras (i-TTL autofocus)	
Guide No. (1/1 output @ 200mm)	60 (m ISO 100) 190 (feet ISO 100)	
Flash Coverage	20 to 200mm (14mm with wide panel)	
	• Auto zoom (Flash coverage set automatically to match the lens focal length and image size)	
	• Manual zoom	
	• Swinging/tilting flash head (bounce flash): 0 to 360° horizontally and -7° to 90° vertically	
Flash Duration	1/300 to 1/20000 seconds	
<b>• Exposure Control</b>		
Exposure control system	i-TTL autofocus and manual flash	
Flash exposure compensation (FEC)	Manual. FEB: ±3 stops in 1/3 stop increments (Manual FEC and FEB can be combined.)	
Sync mode	High-speed sync (up to 1/8000 seconds), first-curtain sync, and second-curtain sync	
Multi flash	Provided (up to 90 times, 100Hz)	
<b>• Wireless Flash (Optic transmission and 2.4G transmission)</b>		
Wireless flash function	Master, Slave, Off	
Controllable slave groups	3 (A, B, and C)	
Transmission range (approx.)	Optic	Indoors: 12 to 15 m / 39.4 to 49.2 ft.
		Outdoors: 8 to 10 m / 26.2 to 32.8 ft.
		Master unit reception angle: ±40° horizontally, ±30° vertically
	2.4G	100m
Channels	Optic	4 (1, 2, 3, and 4)
	2.4G	32 (1-32)
Slave-ready indicator	Two red indicators blink	
Modeling flash	Fired with camera's depth-of-field preview button	
<b>• Auto Focus Assist Beam</b>		
Effective range (approx.)	Center: 0.6~10m / 2.0~32.8 feet	
	Periphery: 0.6~5m / 2.0~16.4 feet	
<b>• Power Supply</b>		
Power source	11.1V/2000mAh Li-ion polymer battery	
Recycle time	<1.5 seconds. Red LED indicator will light up when the flash is ready.	
Full power flashes	Approx. 650	
Power saving	Power off automatically after approx. 90 seconds of idle operation. (60 minutes if set as slave)	
<b>• Sync Triggering Mode</b>	Hotshoe, 2.5mm sync line, Wireless control port	
<b>• Color Temperature</b>	5600±200k	
<b>• Dimensions</b>		
W x H x D	64*76*190 mm	
Weight without battery	430g	
Weight with battery	540g	

## Troubleshooting

If there is a problem, refer to this Troubleshooting Guide.

### The Camera Flash does not fire.

- The camera flash is not attached securely to the camera.
  - Attach the camera's mounting foot securely to the camera.
- The electrical contacts of the Camera Flash and camera are dirty.
  - Clean the contacts.

### The power turns off by itself.

- After 90 seconds of idle operation, auto power off took effect if the flash is set as master.
  - Press the shutter button halfway or press any flash button to wake up.
- After 60 minutes (or 30 minutes) of idle operation, the flash unit will enter sleep mode if it is set as slave.
  - Press any flash button to wake up.

### Auto zoom does not work.

- The camera flash is not attached securely to the camera.
  - Attach the camera flash's mounting foot to the camera.

### The flash exposure is underexposed or overexposed.

- You used high-speed sync.
  - With high-speed sync, the effective flash range will be shorter. Make sure the subject is within the effective flash range displayed.
- You used Manual Flash mode.
  - Set the flash mode to **i-TTL** or modify the flash output.

### Photos have dark corners or only parts of the target subject are illuminated.

- The focal length of lens exceeds the flash coverage.
  - Check the flash coverage you set. This flash unit has the flash coverage between 20 and 200mm, which fits medium-format cameras. Pull the wide panel out to extend the flash coverage.

## Firmware Upgrade

This flash supports firmware upgrade through the USB port. Update information will be released on our official website.

- USB connection line is not included in this product. The USB port is a standard Micro USB socket. Common USB connection line is applicable.

## Compatible Camera Models

This flash unit can be used on the following

**Nikon DSLR camera models:**

D800	D700	D7100	D7000	D5200	D5100	D5000
D300	D300S	D3200	D3100	D3000	D200	D70S
D810	D610	D90	D750			

- This table only lists the tested camera models, not all Nikon DSLR series cameras. For the compatibility of other camera models, a self-test is recommended. Rights to modify this table are retained.

## Maintenance

- Shut down the device immediately should abnormal operation be detected.
- Avoid sudden impacts and the product should be dedusted regularly.
- It is normal for the flash tube to be warm when in use. Avoid continuous flashes if unnecessary.
- Maintenance of the flash must be performed by our authorized maintenance department which can provide original accessories.
- This product, except consumables e.g. flash tube, is supported with a one-year warranty.
- Unauthorized service will void the warranty.
- If the product had failures or was wetted, do not use it until it is repaired by professionals.
- Changes made to the specifications or designs may not be reflected in this manual.

## FCC Warning

This device complies with part 15 of the FCC Rules. Operation is subject to the following two conditions: (1) This device may not cause harmful interference, and (2) this device must accept any interference received, including interference that may cause undesired operation.

Any Changes or modifications not expressly approved by the party responsible for compliance could void the user's authority to operate the equipment.

**Note:** This equipment has been tested and found to comply with the limits for a Class B digital device, pursuant to part 15 of the FCC Rules. These limits are designed to provide reasonable protection against harmful interference in a residential installation. This equipment generates uses and can radiate radio frequency energy and, if not installed and used in accordance with the instructions, may cause harmful interference to radio communications. However, there is no guarantee that interference will not occur in a particular installation. If this equipment does cause harmful interference to radio or television reception, which can be determined by turning the equipment off and on, the user is encouraged to try to correct the interference by one or more of the following measures:

- Reorient or relocate the receiving antenna.
- Increase the separation between the equipment and receiver.
- Connect the equipment into an outlet on a circuit different from that to which the receiver is connected.
- Consult the dealer or an experienced radio/TV technician for help.

**\*RF warning:**

This equipment complies with FCC radiation exposure limits set forth for an uncontrolled environment. This equipment should be installed and operated with minimum distance 20cm between the radiator & your body.